

CSP 120/200

Conduction-cooled capacitor

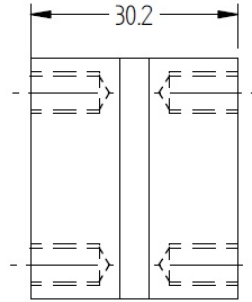

Technology Patented Worldwide

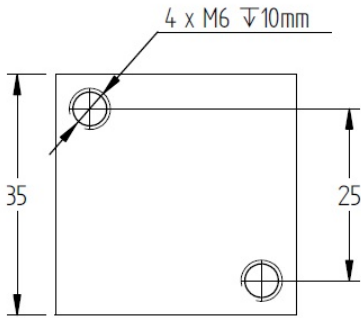

The new CSP120/200 is replacing the old CSP120.

With 200kVAr, almost double the power of CSP120, but at the same physical dimensions, the new capacitor is an ideal solution for applications that require high power at a small volume.

Specifications

Type		CSP 120/200							
Dimensions (L x W x H)	mm	35 x 35 x 30.2							
Weight	kg	0.17							
Capacitance ($\pm 10\%$)	μF	0.025 μF	0.05 μF	0.085 μF	0.17 μF	0.25 μF	0.33 μF	0.66 μF	1.2 μF
Sinusoidal Voltage	V _{rms}	1100	1000		900	800	700	600	500
Peak_Voltage	V	1560	1410		1270	1130	990	850	710
Max. Current	A _{rms}	200			250	270	300	350	400
Max. Power	kVA _r	180			200				
Freq Range @ Full Power	kHz	947-1415	573-707	374-374	231-293	199-232	197-217	134-148	106-106
Stray Inductance	nH	< 3							

Celem Power Capacitors

Produced: 24-11-2019



CSP 120/200

Conduction-cooled capacitor

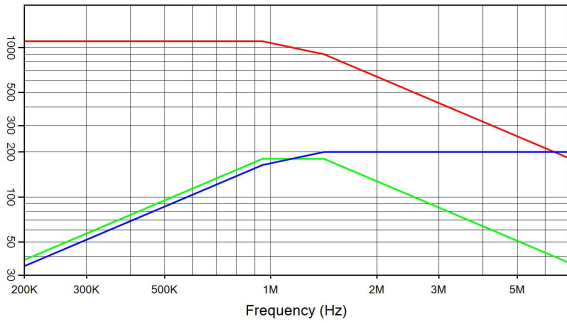

CSP 120/200 0.025 µF 1100 V_{rms} 200 A_{rms} 180 kVA_r
 I(A) — Q(kVA_r) — V_{rms} — V_{rms}

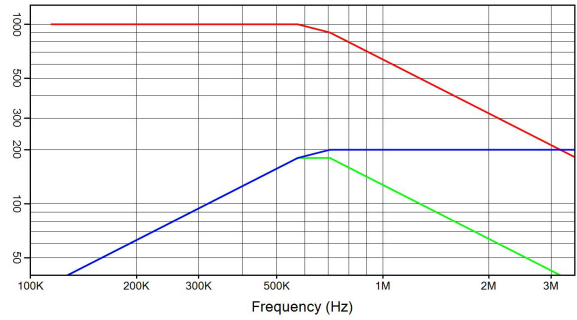

CSP 120/200 0.05 µF 1000 V_{rms} 200 A_{rms} 180 kVA_r
 I(A) — Q(kVA_r) — V_{rms} — V_{rms}

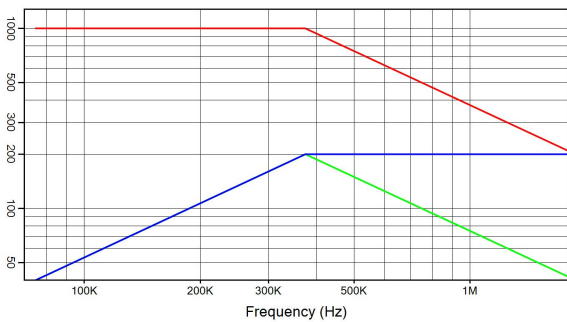

CSP 120/200 0.085 µF 1000 V_{rms} 200 A_{rms} 200 kVA_r
 I(A) — Q(kVA_r) — V_{rms} — V_{rms}

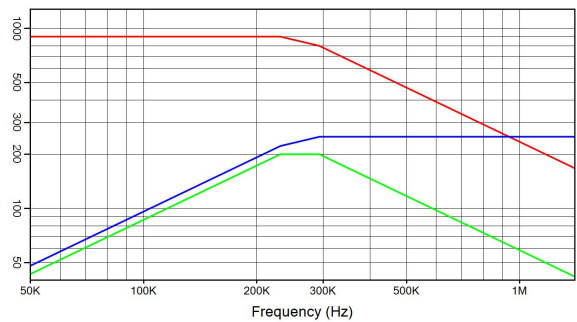

CSP 120/200 0.17 µF 900 V_{rms} 250 A_{rms} 200 kVA_r
 I(A) — Q(kVA_r) — V_{rms} — V_{rms}

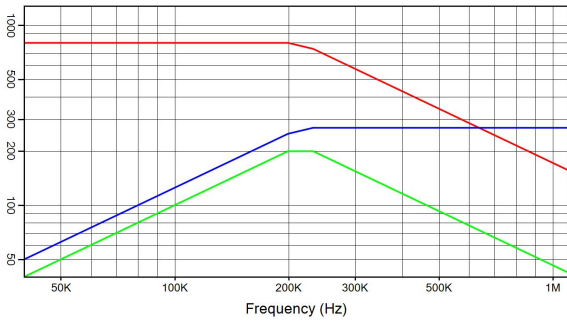

CSP 120/200 0.25 µF 800 V_{rms} 270 A_{rms} 200 kVA_r
 I(A) — Q(kVA_r) — V_{rms} — V_{rms}

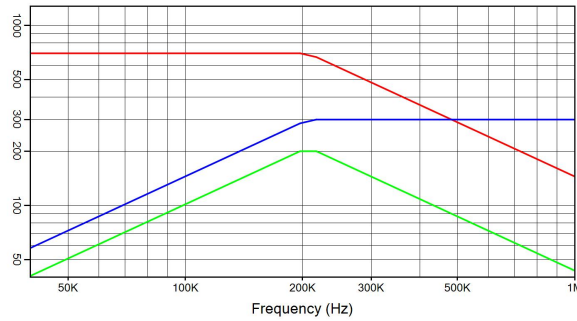

CSP 120/200 0.33 µF 700 V_{rms} 300 A_{rms} 200 kVA_r
 I(A) — Q(kVA_r) — V_{rms} — V_{rms}

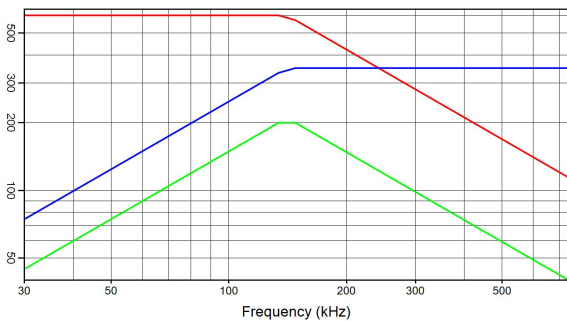

CSP 120/200 0.66 µF 600 V_{rms} 350 A_{rms} 200 kVA_r
 I(A) — Q(kVA_r) — V_{rms} — V_{rms}

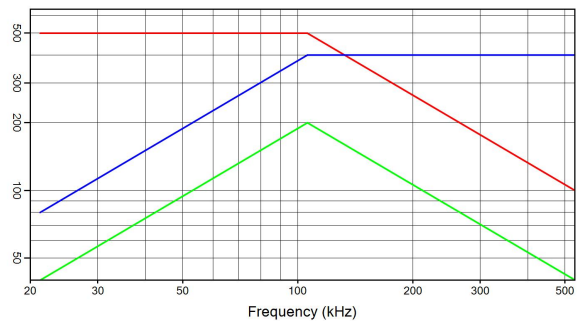

CSP 120/200 1.2 µF 500 V_{rms} 400 A_{rms} 200 kVA_r
 I(A) — Q(kVA_r) — V_{rms} — V_{rms}